



MAGNATRACK™
BY A SHADE ABOVE

MAGNATRACKCHARLOTTE.COM

Progressive in Approach, Innovative in Design

Progressives Screens is committed to being the industry leader in providing the highest quality motorized retractable screening solutions and innovative designs that set us apart from our competition. Our primary mission is to provide customers with world-class motorized screens, each of which are customized to fit your needs.

Progressive Screens guarantees top quality workmanship and materials in every system we produce. All backed by an industry leading Limited Lifetime Warranty that will protect your investment for years to come.



04

About Progressive Screens

07

MagnaTrack

08

Defender Hurricane Systems

15

Get to Know Our System

18

Home Automation

22

Screen & Vinyl

24

Residential

30

Commercial

37

Swatches

40

Care & Cleaning

Why Progressive Screens?

Founded in 2002 by Arthur James, Jr., Progressive Screens is your source for motorized screens. Arthur and his team bring extensive knowledge and has spent the last 22 years perfecting our screen system to be the best available, at an affordable price. Whether you're looking for screen, vinyl solutions, hurricane protection, commercial or residential, our system is completely customizable to fit your needs. Each product goes through our quality control inspections to ensure every system is built to your exact specifications and meets our stringent guidelines.

Progressive Screens is the top pioneer in the industry. We bring you innovative design and solutions. Our one of a kind, MagnaTrack System (US Patent No. 11421474) works on a dual pull magnetic system and eliminates nearly 98% of common service issues associated with other motorized screens and is guaranteed to outperform any other system available.

Our world-class motorized screen system is proudly manufactured in the USA with headquarters based in Sarasota, FL. As a Hunter Douglas owned and operated business every client is important to us and our world class customer service representatives are glad to assist you with any questions you may have.



“Durability, protection, and performance! Our patented MagnaTrack system is like no other and will outperform any other in the industry.”

US Patent No. 11421474

Arthur James

President/Founder



98% of service issues inherent of all fixed track/zipper systems are eliminated with our MagnaTrack system.

Guaranteed to outperform the competition





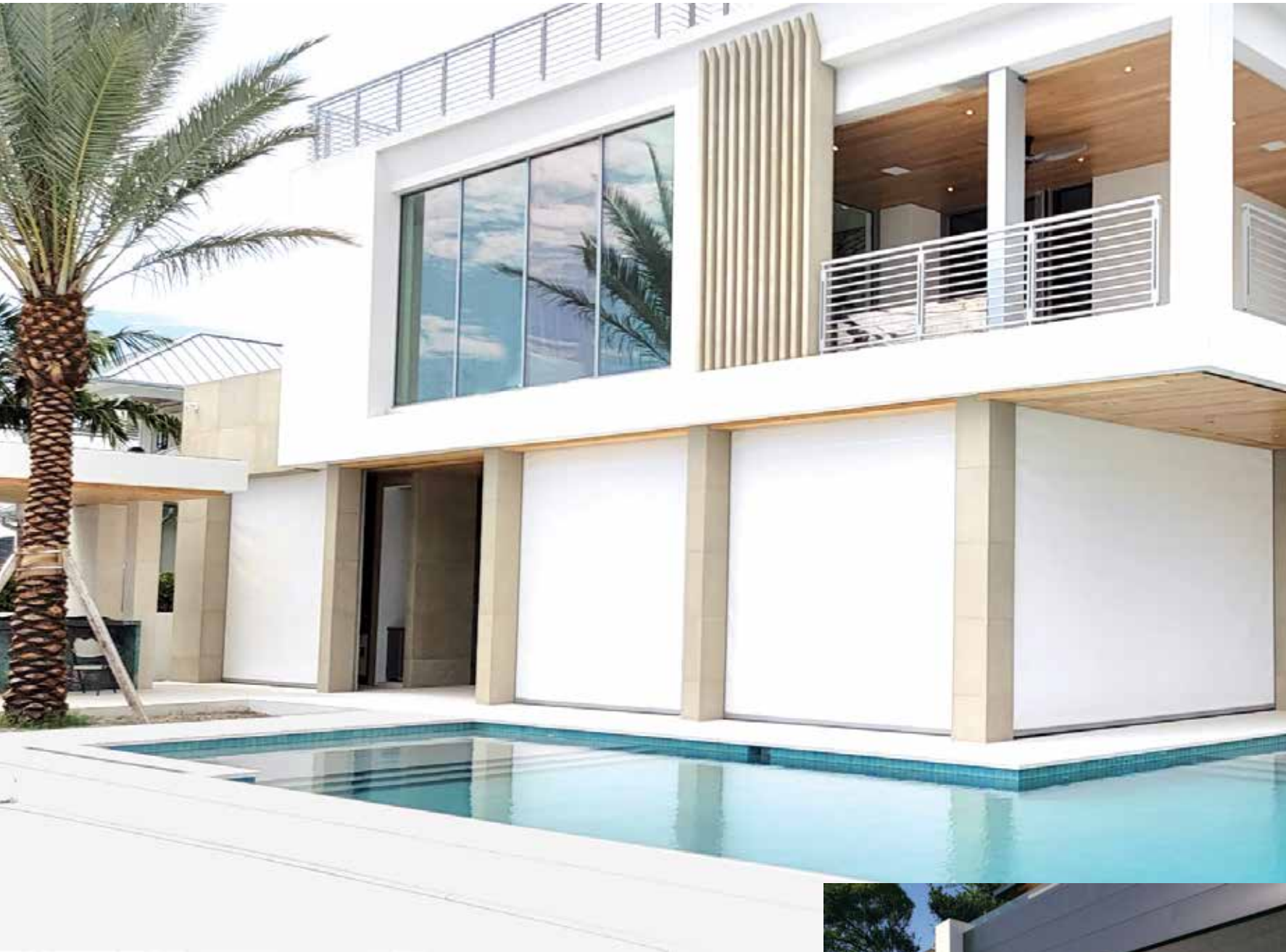





MagnaTrack outperforms across the board: the best durability, protection and performance.

	 MAGNATRACK	OTHER MOTORIZED SCREENS
Increased Energy Savings	✔ Stops over 58% of heat penetration	✔ Some energy savings
Motorized	✔ Motorized screen system	✔ Motorized
Maintenance Free	✔ 98% less maintenance calls	✘ Recurring service calls
75 MPH Wind Rated	✔ Can handle large wind gusts	✘ Zipper screens could break
Hurricane-Grade	✔ Defender Hurricane available	✘ No protection
Customizable	✔ Select color, size, and usage	✔ Some custom options
Self-Correcting	✔ Dislodged screen auto corrects	✘ Need service tech to fix
Impact Resistant	✔ Can handle body impact	✘ Impact may dislodge screen
Patented Technology	✔ Free floating magnet track	✘ Outdated zipper based systems
Accommodates Uneven Floors	✔ Up to 4' bias	✘ Not possible



One screen. Multiple lines of defense.











Built tough to withstand Category 5 hurricane winds to help protect against unimaginable damage to your home. Perfect for everyday use, including:

-  Category 5 Hurricane Defense
-  Texas TDI
-  Insect protection
-  Solar protection
-  Privacy
-  Beautiful in appearance
-  No sagging screens
-  Increased Energy Efficiency
-  Outperforms all others
-  Approval code FBC#30798

Our Defender Hurricane System meets and exceeds Miami Dade NOA, Florida Building Code and Texas TDI Requirements for roll-down hurricane screens.



Introducing the Defender Hurricane Screen by Progressive MagnaTrack

	Category 5 Hurricane Protection
	Exceeds all Miami Dade NOA, Florida Building Code and Texas TDI specifications for Hurricane Protection
	Unparalleled strength and durability for hurricane protection
	Constructed with cutting-edge technology and premium materials
	Meticulously tested to meet the highest standards of quality and performance
	Advanced MagnaTrack system provides unmatched stability and protection
	Built to last with high-quality materials and a state-of-the-art manufacturing process
	Customizable design for seamless integration into any architectural style
	Quick and easy deployment for hassle-free protection
	Sets the new standard for safeguarding your property during hurricane seasons
	Insect, Solar, Privacy, and Storm Protection! Multiple lines of defense, all in one system

Get tough with our Hurricane Defender Screens

System

Structurally-engineered roller and weight bars are unparalleled in strength, rigidity and durability. Our Defender Hurricane Screen System uses MagnaTrack™ technology that is integrated with an exclusive reinforcement channel; this is the only system in the world that uses magnetic fields to dampen the impact of wind loads and flying debris while maintaining a flat and uniform screen surface appearance when deployed.

Self Adjusting Technology (SAT) built into every system, allows the screen to freely deploy in windy conditions without hang-ups or rewraps, common in other competitive products. Spans up to 30' wide and 20' tall. Defender Screens use a Proprietary fabric with a blend of high tenacity core yarns encapsulated with a durable vinyl that defends against severe hurricanes, insects, solar rays and offers maximum outdoor privacy. All fabrics used in Defender Screens come with a 15 year warranty.

Screen

Defender Screens use a Proprietary fabric with a blend of high tenacity core yarns encapsulated with a durable vinyl that defends against severe hurricanes, insects, solar rays and offers maximum outdoor privacy. All fabrics used in Defender Screens come with a 15-year warranty.

Defender Screen fabrics are "self-extinguishing," unlike most competitive

Polypropylene fabrics that are highly flammable, break down easily from U.V. rays and can only be used in the event of a storm. Our Defender Screens can be used anytime of the year. Defender Screens can always be used 24/7 and 365 days a year. Our patented system is built for unparalleled impact absorption, delivered by our MagnaTrack technology.

Automation

At the push of a button, all Defender Screens can be controlled by a remote, smartphone or home automation system. In addition, all are available for use with fixed controls. Using our MagnaTrack Bridge allows seamless integration to all smart home systems and allows controllability from anywhere in the world.



Fixed Tracks

Introducing Defender Fixed Track Hurricane Screens

When it comes to safeguarding your property against the wrath of Mother Nature, you need a solution that offers unparalleled protection.

Don't compromise when it comes to protecting your family or business - choose Defender Fixed Track Screens! Our Defender Fixed Track Hurricane screens are designed and tested to meet and exceed Category 5 (156mph+) Hurricane Protection (FBC applicable). With a sleek and versatile design, they seamlessly blend with any architectural style, enhancing the overall aesthetic appeal of your home or business all while keeping you safe from anything Mother Nature sends your way. Two-sided application and removable when not required. Easy to store and install. Designed for Window & Door Protection.

Max Sizes
10W x 20H
20W x 10H

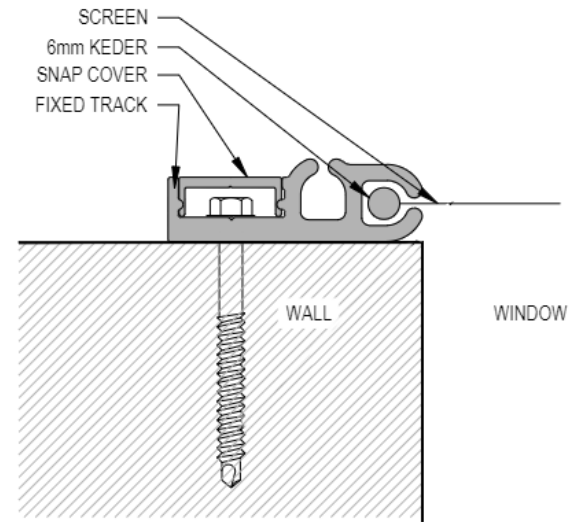

1 SECTION - FACE MOUNT
SCALE: 12" = 1'-0"

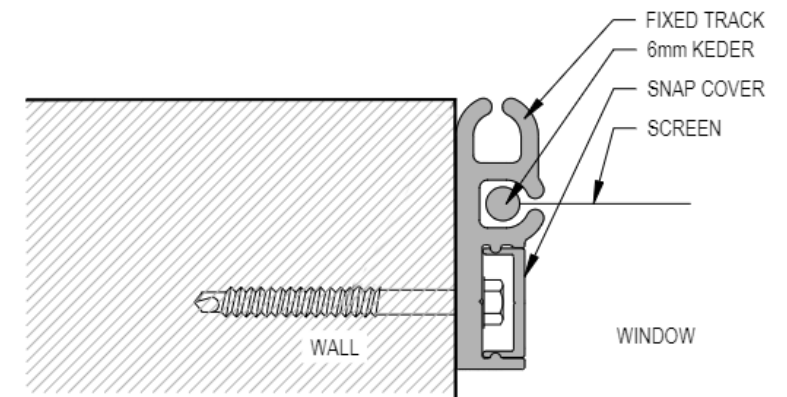

2 SECTION - INSIDE MOUNT
SCALE: 12" = 1'-0"

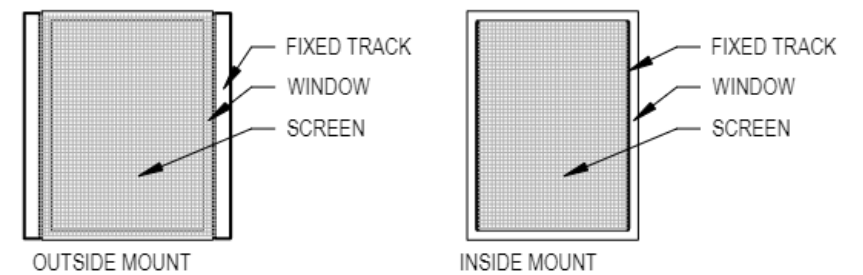

3 ELEVATIONS
SCALE: NTS

Highest Quality. Carefully Crafted.

Our exterior shade systems are the industry leader because of our high quality construction and materials. Each one of our shades is carefully crafted to your project specifications by an experienced team. It then goes through several quality control inspections during each process to ensure you're getting the best product.

We can handle both commercial and residential applications with custom sizes up to 30 feet wide and 20 feet tall (limitations apply). We can easily install into new construction or retrofit applications for either residential or commercial buildings.

Several types of remotes, hand-held and in-wall remotes are available for our systems to accommodate each unique situation. Units plug directly into 110 volt outlet so you don't have to worry about hard wiring or hiring an electrician.

Our Gaposa Motor has a built in triple obstacle detection which eliminates the worry of common rewrap situations. Together with our patented MagnaTrack system, this creates a fail proof motorized screen system. Using our MagnaTrack Bridge allows seamless integration to all smart home systems and allows controllability from anywhere in the world.



Made in USA

Hand made to your exact specifications in our world class facility in Sarasota, Florida.



Quality

We only use the finest quality materials and components built to withstand the most rigorous conditions.



Value

Enhances your outdoor living area, adds value, and protects your home from harmful UV Rays and those pesky insects.

Get to know our shade system

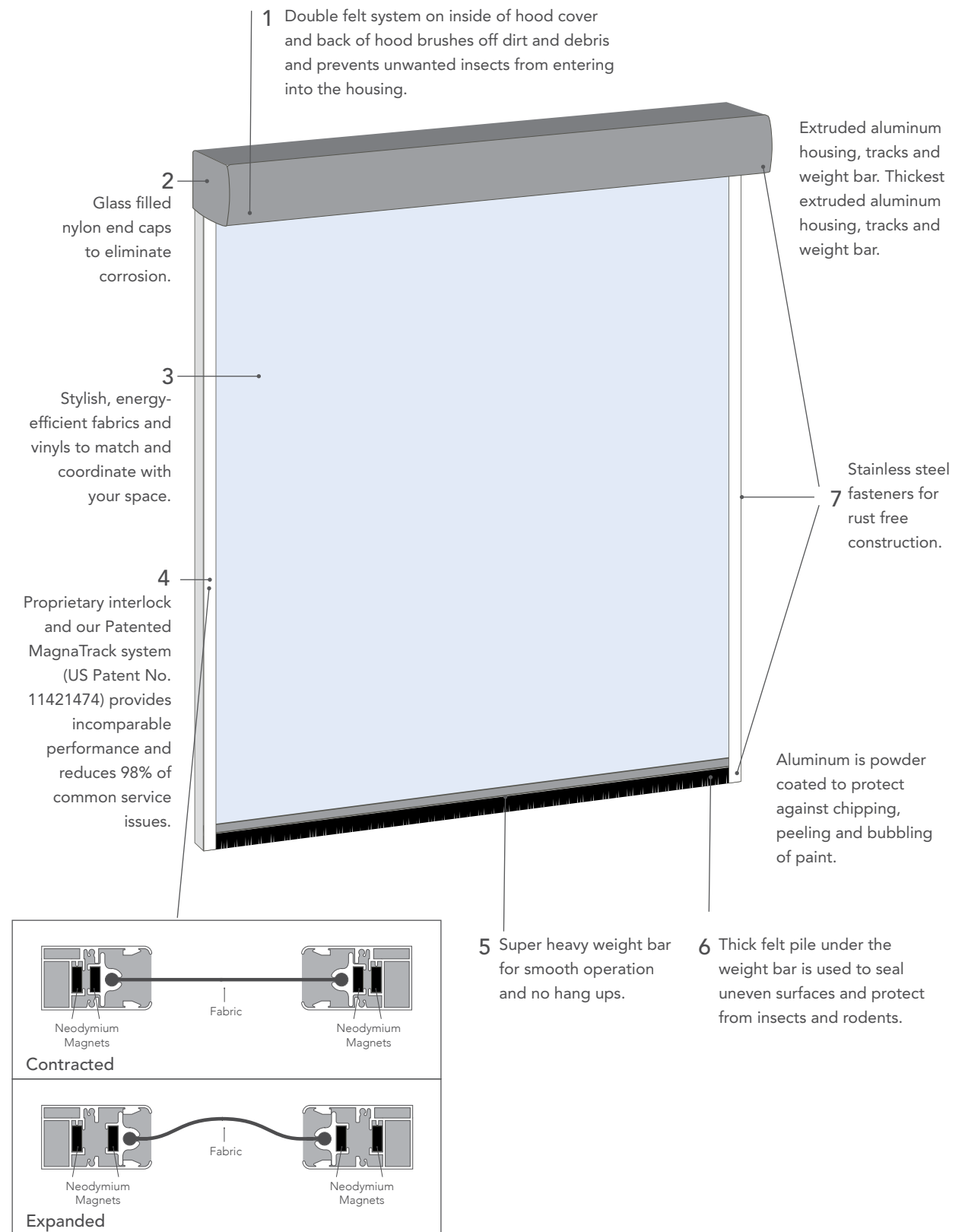

Key Components

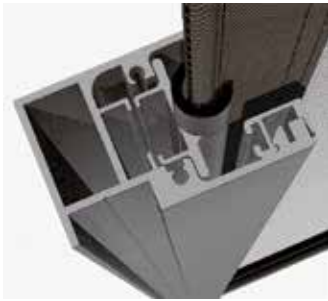

Effortless Deployment

Our low friction Keder interlock means your screen is secure with absolutely no zippers.



Strongest Yet Quiet Operation

Our magnet track has more than 10x the pulling force of any other system in the market!



Self-Adjusting Sidetracks

Our innovative design prevents openings and fabric bowing in windy conditions.



Adjustable Roller System

Made to reduce wrinkled edges for a clean aesthetic appearance.



Weighted Bottom Bar

Rated as the heaviest in the industry for easy deployment.

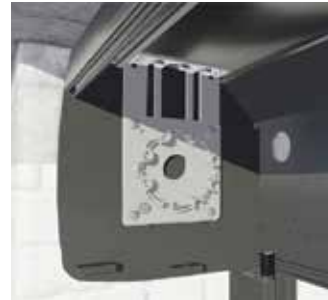

Aluminum Housing Bracket

For utmost strength and durability. Coated in glass filled nylon to eliminate corrosion.



Extruded Hood Design

Stylish, durable and engineered to accommodate wide spans without deflection.

Pre-Construction Bracket Kit

Mounting for recessed applications has never been easier. Introducing the New MagnaTrack Pre Construction brackets. Configured for all roller sizes, these convenient brackets take the guesswork out of recessed pockets. Now you can simply build around the bracket for the perfect pocket size no matter the configuration.

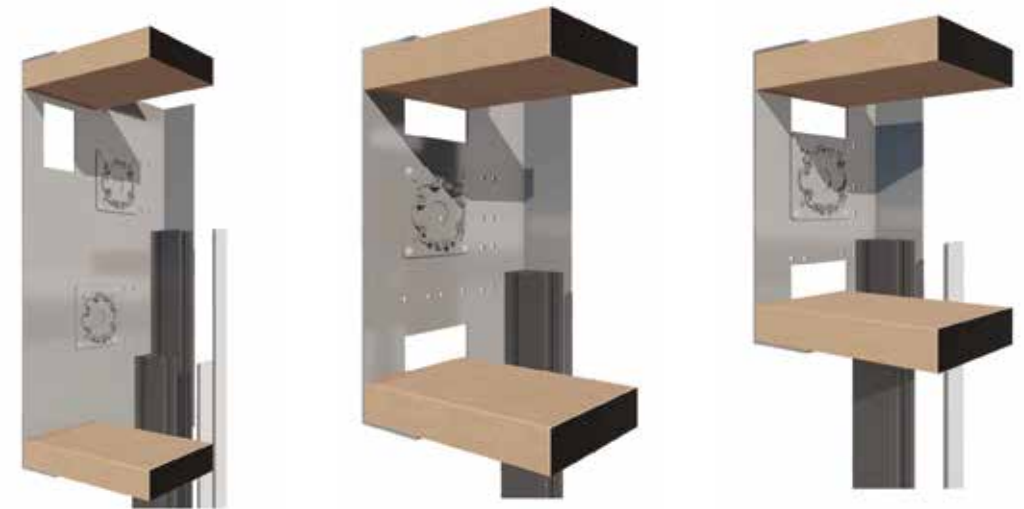

Dual

✓	4" Roller
✓	5.75" Roller
✓	6.5" Roller

Medium - Single

✓	4" Roller
✓	5.75" Roller
✓	6.5" Roller

Small - Single

✓	4" Roller
✓	5.75" Roller

Motors, Transmitters & Home Automation

Gaposa Sense Tubular Motors

with obstacle detection and automatic limit setting for roller screens.

- ✓ Downward sensitive obstacle detection
- ✓ 3 attempts to identify the physical obstacle before stopping
- ✓ Smart reaction to gusts of wind: stop/reverse and downwards again
- ✓ Overload protection upwards
- ✓ Soft touch and slight release at the up limit position
- ✓ Continuous fabric length compensation
- ✓ 3 setting modes: automatic, semi-automatic and manual
- ✓ Self-learning limit positions when set in automatic mode



Gaposa SHSM Super High Speed Motors for Egress

MagnaTrack exclusive. Electric encoded type with built-in radio receiver.

- ✓ Automatically opens in case of emergency when connected with fire alarms or other control systems allowing dry contacts connections
- ✓ Runs at 90 RPM
- ✓ Easy limit setting via radio
- ✓ Secure 434.15 MHz radio transmission
- ✓ Easy set up of group controls
- ✓ Up and down directions synchronized while setting the limits
- ✓ Wireless connection with climatic sensors
- ✓ Noiseless soft brake
- ✓ Plug-in cable

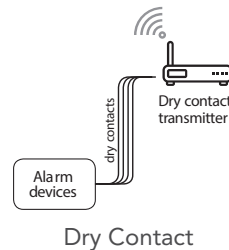







Panic Button

Emitto SMART LINE

Transmitters

Emitto SMART LINE is the new range of portable and wall transmitters for the control of residential motorization. Emitto SMART LINE is flexible, expandable, simple to use.

	QCTZ16Y Magnetic Wall Mount Bracket 16 Channels		QCTZ01Y Portable 1 Channel
	QCTZ02Y Portable 5 Channels		QCTZ01D Wall Mounted 1 Channel
	QCTZ02D Wall Mounted 5 Channels		QCTZKP Wall Mounted Key Pad 2 Channels

Gaposa 3rd Party Integration

via dry contacts with: Lutron, Savant, Control4, Crestron

Panels with integrated transmitter enables to interface a radio motors with a home automation system. In this way, the home automation system will control the radio motor(s) through UP/STOP/DOWN signals.

	QCTZ2SDU 1 Channel		QCTZ236SDU 6 Channels
---	------------------------------	---	---------------------------------

Gaposa Autonomo Solar Motors

Green energy solution scientifically designed to deliver the best performing solar motor combination of power, speed and durability.

- ✓ 100% Solar powered motors
- ✓ Quick connect kit; pre-wired motor, battery and solar station
- ✓ No wiring to electrical power line
- ✓ Saving in energy costs
- ✓ Easy assembly
- ✓ Quick installation
- ✓ Double obstacle detection
- ✓ Weatherproof solar stations



Motors, Transmitters & Home Automation

MagnaTrack Bridge - The Whole Story



MagnaTrack and MagnaTrack + PoE are low frequency RF to Wi-Fi/Ethernet bridges. They were created and designed for Pro Installers who demand to take the experience of using a Smart Bridge to the next level. It is an easier, faster, and more powerful way to connect RF controlled devices in a smart home automation portfolio. Just mount the Magnatrack Bridge to the wall or ceiling in a central location, to allow for full coverage and control of RF devices within the entire home. And we are Open! Our open API allows integrations with all home automation systems.

✓	Magnatrack Bridge are two Sub GHz to Wifi (TCP/IP) Bridges
✓	Cover remote controls between 300MHz - 450MHz
✓	Both models can control Gafosa and Somfy motors
✓	2.4GHz Wi-Fi, Ethernet, with and without POE
✓	Drivers for C4, Elan, RTI, URC and more
✓	Live tech support

Integrations

MagnaTrack is focused on compatibility and supports a wide range of integrations:

Control 4	Gafosa (motors)
ELAN	Simu/Somfy (motors)
RTI	Google Assistant
URC	Amazon Alexa
Savant	Smart Things
Crestron	Josh.ai
Lutron (2 devices)	+ Open API

	BD-1720 MagnaTrack Bridge
	BD-1740 MagnaTrack Bridge + PoE





Use your screens as a 2-way image, outdoor projector screen. Contact your local distributor for options.

Sidekick System - The Whole Story

Sidekick is the only keypad in the industry that can communicate directly with multiple motor technologies, such as; Somfy RTS, Rollease ARC, Dooya, AMP Motorization, and more. By doing so, it provides direct, individual, and group control with no advance planning or wiring required. When used with the Bond Bridge Pro (instead of Sidekick), extending the technologies it supports, its range and battery life.

✓	Works with multiple motor technologies
✓	5-channel or 1-channel control
✓	Pairs directly with the shade
✓	Wireless control via RF
✓	10-year battery life
✓	Flush mount: Install with or without a workbox
✓	Provides State feedback to the Bond Bridge Pro
✓	Set up shade limits
✓	No manufacturer remote required

	SKS-500 - Gen 1 Sidekick Remote Control 5 Channel
	SKS-500 - Gen 2 Sidekick Remote Control 1 Channel & 5 Channels

Screen & Vinyl



Solar & Insect



Privacy

Our mesh is perfect for an added layer of privacy all while still enjoying a gorgeous day outdoors. For maximum privacy, day or night, color selections is most important. Lighter colors will reflect light and obscure view. Darker fabrics will provide best visibility day or night. Solar fabrics are available in 70%-97% UV blockage and privacy fabrics.



Shading

Since our screens block harmful UV rays, cooling and energy costs are reduced even on the most sweltering summer days. Privacy fabrics block about 80%-100% of harmful UV rays and are available in many colors to suit your style.



Insect Protection

Safeguard against insects while maximizing airflow through your space. Our 16/14 mesh is optimal for maximum air flow and to protect from flies and mosquitoes, or 17/20 for protection from those tiny insects or noseemus.

Vinyl Screens



Energy Savings

Our vinyl system allows you to control temperature and protect from weather elements in your outdoor space. In cooler climates, the system assists to keep the warmth in and the weather out. In hotter climates it's perfect for retaining cool air so you can enjoy your outdoor living space and extend your living area.



Fabric Options

Enhance your patio or dining space with a customized look. Many color options are available for your border material to create the perfect combination that will expand your outdoor space for you and your guests.



All Season Use

Make the most of your outdoor space by making it accessible year round. Our proven, customizable vinyl-system helps conditioned air slowly dissipate and contains heat generated by heating systems, creating an extended living area for you to enjoy all year round, hot or cold, rain or shine.

Residential

Live more.

Use more.

Enjoy More.

Maximize and extend your outdoor living area potential with our screen or vinyl systems. Garages, patios and decks become more livable during uncomfortable weather months and keep your space clean from debris and pesky insects all while protecting you and your belongings from harmful UV Rays.



“We extend, enhance and protect your outdoor areas.”

Residential Screen Systems

Make better use of your outdoor living areas by adding privacy and shading to keep cooler in warmer months.

Keep the pests out while you enjoy your outdoor living space.

Screens can be used as a projector screen for a movie night with friends and family.

Designed to withstand various weather conditions keeping your space free from debris.

Protect your home, family and guests from harmful UV rays while still enjoying the outdoors.

Made to your specifications to match your home's style and architecture.

Archways? No problem. These can be easily screened in while still maintaining their unique beauty.

Screens can be made 3'-30' wide and 3'-24' tall, (limitations apply) accommodating many openings.

Perfect for new construction homes or remodels.



Residential Vinyl Systems

Enhance the functionality of the outdoor space by extending the usage of the area in all seasons.

Protect your outdoor living area from rain, wind and debris.

Multiple fabric options are available for the border around the vinyl windows that will let you design the perfect combination that will enhance your patio and dining area.

Energy-Efficient: it is proven that our vinyl system offers year-round benefits. It slows the dissipation of conditioned air and contains heat generated by heating systems, thus reducing the length of time normally needed to run saving you money.

Our system is the only "wide span" full "end retention" system available up to 26' wide and 18' tall.

Easy to operate by remote control or integrated automation that allows control for the system from your table or smart phone using the My Link, Roll App or RTS Interface.



Commercial

Increase your ROI by extending your outdoor spaces seasons. Progressives durability and best in class performance are why so many brands trust progressive MagnaTrack for their guests enjoyment.



After years of testing and safe operations, we are the preferred vendor for the world's top brands.



Commercial Screen Systems

Our commercial screens are perfect for restaurant outdoor dining areas, hotels, resorts, casinos and so much more.

Keep the birds, rodents, insects out while your guests enjoy your outdoor space.

Designed to withstand treacherous weather conditions, keeping your space free from debris.

Screens add a layer of shading keeping your guests cool in the warmer months.

Made to your specifications to match any branding or themes you have.

Save money by covering multiple openings instead of purchasing individual screens.

Commercial screens can be made 26' wide and 18' tall, accommodating many openings.

Complete end retention system, no blow out, completely seal your outdoor space.

MagnaTrack is the most trusted and preferred brand for commercial spaces worldwide



Commercial Vinyl Systems

Enhance your outdoor dining area and protect guests from pests and inclement weather, while still providing a great dining experience.

Expand the functionality of your space for year round use and quickly see a return on investment.

Designed to withstand rigorous weather conditions, keeping your space free from debris.

Keep the warmth in cooler months and keep your guests cool in the warmer months.

Made to your specifications to match any branding or themes you have to keep your guests in the right frame of mind.

Vinyl systems can be made 26' wide and 18' tall, accommodating many openings.

Available with clear or tinted vinyl windows.

No cables or pull outs.

Guaranteed performance.

Durable Quality.



Customize Your System

With many options to suit your needs, you'll find exactly the style you want with the properties you need.

We have six classic standard extrusion colors that complement any style. If you're feeling more creative or need to match an existing frame, we can color match and create a custom color to your liking from our RAL selection.

Our screens come in a variety of colors, textures and opacities. All of our screens provide high quality shade and protection to your space, so you can enjoy them worry free for years to come.

* Please note that custom color extrusion pieces can extend delivery dates and come with an additional charge.

** While we use the latest technologies to produce the swatches here in this brochure, due to variations in printing and materials, the colors represented here are subject to variations on actual products. Please use this as a guide. If absolute accuracy is needed, please contact us for a physical swatch.



Extrusion Colors

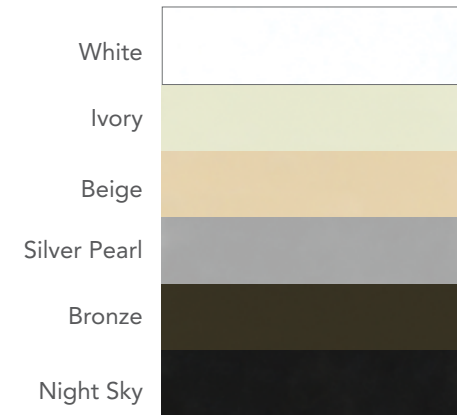

Insect Mesh

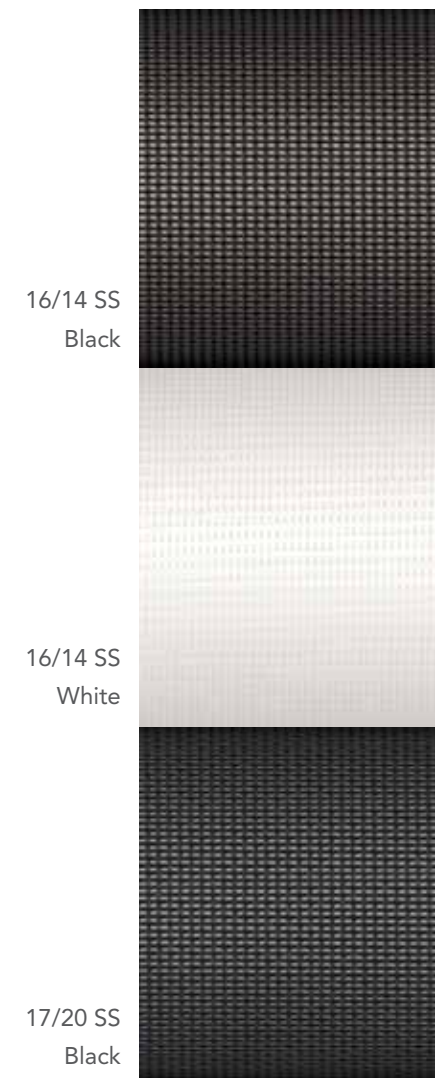

OmegaTex | Defender

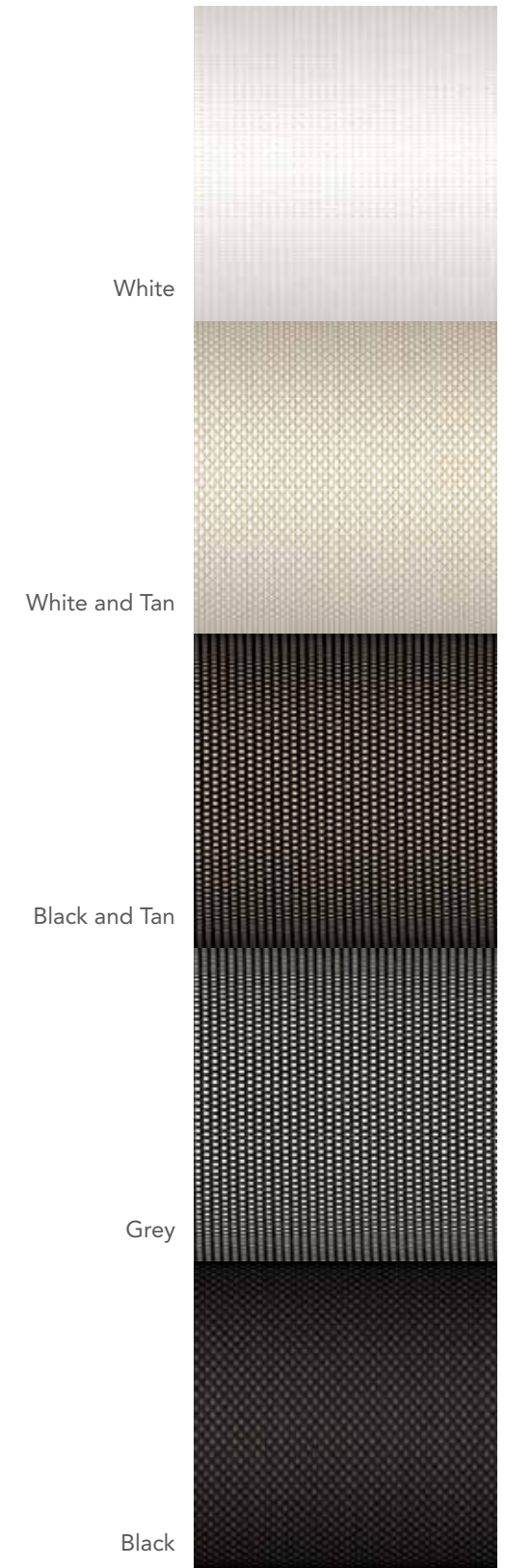

Textilene 80/90

Textilene 95

Textilene 95 Nano

Textilene 97 Nano



Care & Maintenance for Clear Vinyl

Recommended Products for Cleaning:

IMAR Products. IMAR Regalite Protective Polish, IMAR Regalite Protective Cleaner, and mild soap (preferably IMAR Yacht Soap Concentrate). Use of harsh cleaners like "Simple Green, Glass cleaners with Ammonia, and Orpine" will dull the curtains quickly. Using any other product(s) void the factory warranty.

303 Clear Vinyl Protective Cleaner is also approved for cleaning of Vinyl panels. 303 Clear Vinyl protectant offers superior protection against the harmful effects of UV rays. This product is all you need to safely clean and protect against yellowing and cracking of vinyl, clear vinyl, leaving a non-streaking finish.

NEVER use a wash-and-wax product on Vinyl panels.

WARNING – Use of Rain-X, Pledge, or Plexus on your Vinyl panels will appear to work for a short time but then dulls the surface and presents an "Orange Peel" effect. **Do not use any of these products.**

Use of cleaners, polishes, scratch removers, or any other product made for regular, uncoated vinyl will damage your vinyl panels. Do not use these products.

DO NOT HANDLE VINYL WITH SUNSCREEN ON YOUR HANDS! This will permanently cloud the vinyl where handled.

General & Routine Maintenance

For the customer: We recommend using IMAR Regalite protective Polish or 303 Clear Vinyl Protectant or cleaner every 1 to 2 months.

Note: All new vinyl can easily get impressions. It is recommended new enclosures be left in place to the extent possible. Vinyl "seasons" over time and becomes less impressionable. Roll all curtains down and fasten in place nightly to keep perfect appearance.

Cleaning

Apply the soapy water to the clear vinyl section of the curtain with special purpose washing mitt or soft cotton cloths.

Thoroughly rinse the soapy solution with fresh water and completely dry the curtains with a high quality chamois. After washing the curtains, apply 303 or IMAR Regalite Protective Polish sparingly with small, light circular motions using a soft cotton cloth. Allow the polish to dry and then remove with a clean soft cotton cloth. Finally, lightly buff to a sparkling shine. For routine maintenance between polishing, use IMAR Regalite Protective Cleaner. Insure the clear vinyl panels are free of abrasives. Very lightly mist a soft cotton cloth. Lightly and briskly rub a manageable sized area and then lightly buff dry with another clean cloth.

Restoring

Some actual damage cannot truly be repaired. If 303 or IMAR Protective Polish cannot restore the clarity and shine, it may be time to consider replacing the enclosures.



Warranty

LIMITED WARRANTY ON PROGRESSIVE SCREENS MAGNATRACK PRODUCTS THIS LIMITED WARRANTY GIVES YOU SPECIFIC LEGAL RIGHTS AND YOU MAY ALSO HAVE OTHER RIGHTS, WHICH VARY FROM STATE TO STATE.

THE LIMITED WARRANTY CAN ALSO BE FOUND ONLINE AT WWW.PROGRESSIVE SCREENS.COM/WARRANTY.

WE WARRANT THAT, DURING THE WARRANTY PERIOD, THE PRODUCT WILL BE FREE FROM DEFECTS IN MATERIALS AND WORKMANSHIP.

WE LIMIT THE DURATION AND REMEDIES OF ALL IMPLIED WARRANTIES, INCLUDING WITHOUT LIMITATION THE WARRANTIES OF MERCHANTABILITY AND FITNESS FOR A PARTICULAR PURPOSE, TO THE DURATION OF THIS EXPRESS LIMITED WARRANTY.

THE REMEDIES DESCRIBED ABOVE ARE YOUR SOLE AND EXCLUSIVE REMEDIES AND OUR ENTIRE LIABILITY FOR ANY BREACH OF THIS LIMITED WARRANTY SHALL UNDER NO CIRCUMSTANCES EXCEED THE ACTUAL AMOUNT PAID BY YOU FOR THE DEFECTIVE PRODUCT, NOR SHALL WE UNDER ANY CIRCUMSTANCES BE LIABLE FOR ANY CONSEQUENTIAL, INCIDENTAL, SPECIAL OR PUNITIVE DAMAGES OR LOSSES, WHETHER DIRECT OR INDIRECT.

SOME STATES DO NOT ALLOW LIMITATIONS ON HOW LONG AN IMPLIED WARRANTY LASTS, NOR ON THE EXCLUSION OR LIMITATION OF INCIDENTAL OR CONSEQUENTIAL DAMAGES. ACCORDINGLY, THE ABOVE LIMITATION MAY NOT APPLY TO YOU.

OUR RESPONSIBILITY FOR DEFECTIVE PRODUCTS IS LIMITED TO REPAIR/OR REPLACEMENT AS DESCRIBED BELOW IN THIS WARRANTY STATEMENT.

WHO MAY USE THIS WARRANTY?

Defender Screens International d/b/a Progressive Screens located at address 7839 Fruitville Road, Sarasota FL (“we”) extends this limited warranty only to the consumer who originally purchased the product (“you”). It does not extend to any subsequent owner or other transferee of the product.

WHAT DOES THIS WARRANTY COVER?

This limited warranty covers defects in materials and workmanship of all MAGNATRACK PRODUCTS (the “product”) under normal use for the Warranty Period as defined below.

WHAT DOES THIS WARRANTY NOT COVER?

This limited warranty does not cover any damage due to: (a) your transportation or storage of the product; (b) improper installation or use of the product in a manner inconsistent with product instructions, including but not limited to use of the product in excess of standard operating conditions; (c) failure to follow the product instructions, (d) failure to follow the cleaning and maintenance instructions or to perform any preventive maintenance; (e) modifications or alterations; (f) unauthorized repair; (g) normal wear and tear; (h) external causes such as accidents, abuse, or other actions or events beyond our reasonable control, including but not limited to damage caused by acts of god or flying objects/debris; (i) negligent or intentional exposure of a product motor or other electrical components to water/moisture, (j) damage, including chalking, oxidization, erosion of

paint, discoloration, or fading over time due to exposure to the elements (sun, wind, hail, fire, and water/moisture); (k) custom fabrics selected by customer (not included as part of the standard fabric options we offer), (l) damage to vinyl materials, including but not limited to yellowing, scratching or water stains, except for the welding/stitching (which is covered by this limited warranty) and (m) shipping charges, costs of removal, and reinstallation.

WHAT IS THE PERIOD OF COVERAGE?

This limited warranty starts on the date of your purchase and lasts for the period referenced below (the “Warranty Period”). The Warranty Period is not extended if we repair or replace the product. We may change the availability of this limited warranty at our discretion, but any changes will not be retroactive.

Warranty Period for Aluminum components = 15 years

Warranty Period for Electrical components (excluding motors) = 2 years

Warranty Period for Electrical motors = 5 years

Warranty Period for standard Screen materials = 10 years

Warranty Period for welding/stitching of vinyl materials = 1 year

WHAT ARE YOUR REMEDIES UNDER THIS WARRANTY?

With respect to any defective product during the Warranty Period, we will, in our sole discretion, either repair or replace such product (or the defective component or part) free of charge. We will also pay for shipping and handling fees to return the repaired or replacement product to you if we elect to repair or replace the defective product.

HOW DO YOU OBTAIN WARRANTY SERVICE?

In order to obtain warranty service, you should first contact the authorized dealer or retailer from whom you purchased the product, or you may call us directly at 866.802.0400 or email us at warranty@progressivescreens.com. Approved warranty repairs and/or replacements will be handled by our authorized dealers.

MAGNATRACK

magnatrackscreens.com